

FIELD APPLIED POLYURETHANE SEALANT BAND AND CORNER BEADS FORCED DOWN ALONG SIDE OF SSF2 AS SHOWN - BOTH SIDES (SILICONE SUPPLIED BY EMSEAL)

FACTORY APPLIED POLYURETHANE FACING

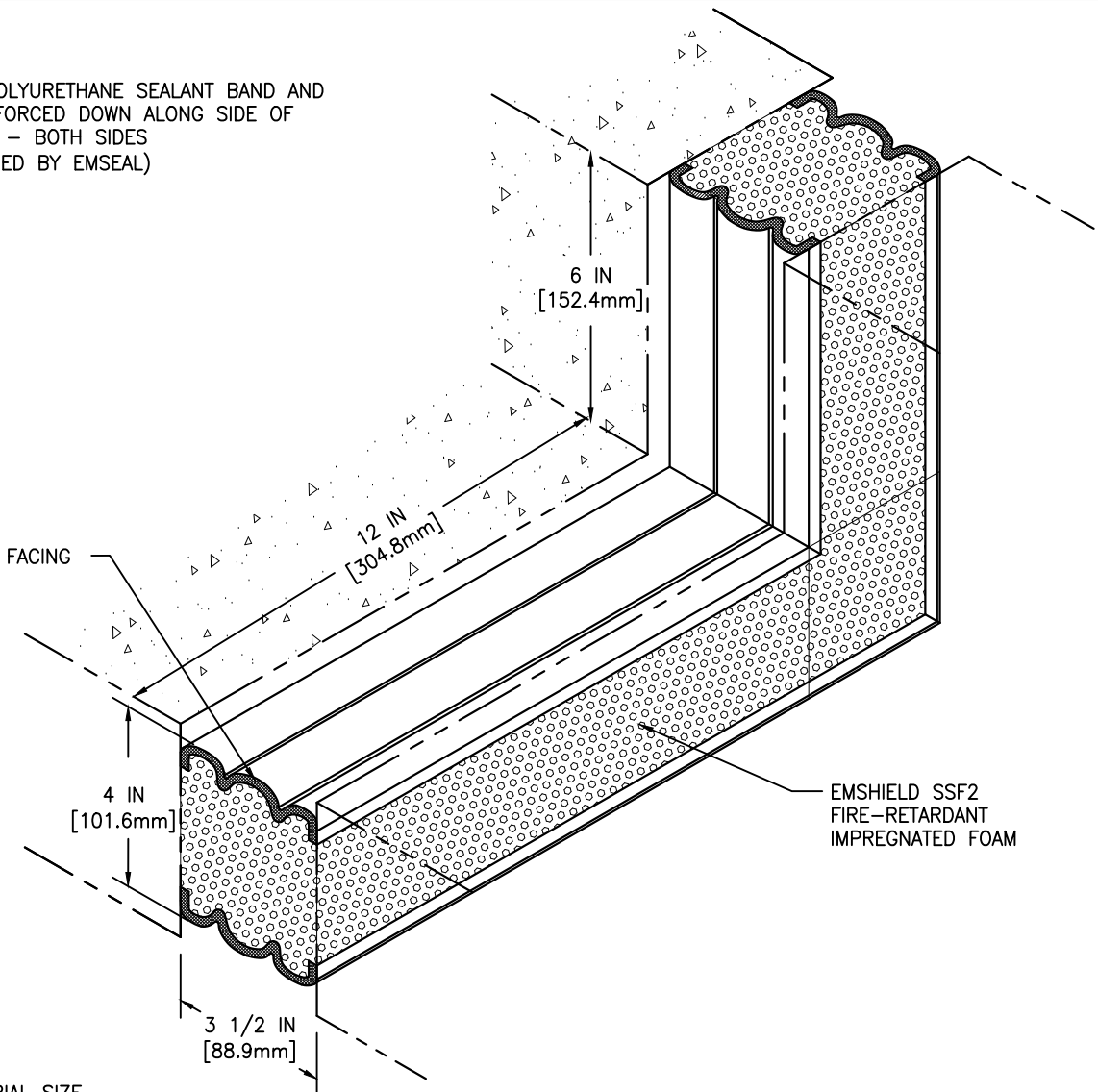

EMSHIELD SSF2 FIRE-RETARDANT IMPREGNATED FOAM

MOVEMENT: ±50% (TOTAL 100%) OF NOMINAL MATERIAL SIZE

EMSEAL'S EMSHIELD SSF2 HAS BEEN TESTED IN ACCORDANCE WITH UL 2079 IN THE CONFIGURATION DEPICTED IN SYSTEM # FF-D-1089. USE OF THIS MATERIAL IN WALL ASSEMBLY CONFIGURATIONS OTHER THAN THAT DEPICTED IN UL SYSTEM # FF-D-1089 WILL NOT ENCUMBER OR LOWER THE RESISTANCE OF THE WALL BUT IS DONE SO AT THE DESIGNERS' DISCRETION AND RESPONSIBILITY FOR DESIGN OF A FIRE RATED WALL ASSEMBLY THAT MEETS APPLICABLE STANDARDS FOR THE PROJECT AND WHICH ADDITIONALLY IS CAPABLE OF RESISTING THE APPROXIMATELY 2.5 PSI (120 LBS PER FOOT OF JOINT BASED ON 4-INCH DEPTH OF SEAL) BACKPRESSURE OF THE SSF2 MATERIAL.

EMSEAL JOINT SYSTEMS LTD.

EMSHIELD SSF2-0350 INSIDE VERTICAL PLANE UNIVERSAL-90

THIS DOCUMENT CONTAINS INFORMATION OF A CONFIDENTIAL NATURE AND IS PROPRIETARY TO EMSEAL JOINT SYSTEMS LTD. ANY UNAUTHORIZED USE WILL BE PROSECUTED. THIS DRAWING IS PROTECTED BY COPYRIGHT, THE RIGHT TO REPRODUCE IN ANY FORM BEING THE EXCLUSIVE RIGHT OF EMSEAL JOINT SYSTEMS LTD. ANY UNAUTHORIZED REPRODUCTION WHETHER IN TWO OR THREE DIMENSIONS WILL BE PROSECUTED. © 2014 EMSEAL JOINT SYSTEMS LTD.

DRAWN BY:	DATE:	SCALE:	SHEET
ORK	2016/10/27	N.T.S.	No: 1 OF 1
PART NUMBER:			
SSF2_0350_U-90_UPTURN			