

WATERTIGHT FACTORY APPLIED  
SILICONE BELLOWS

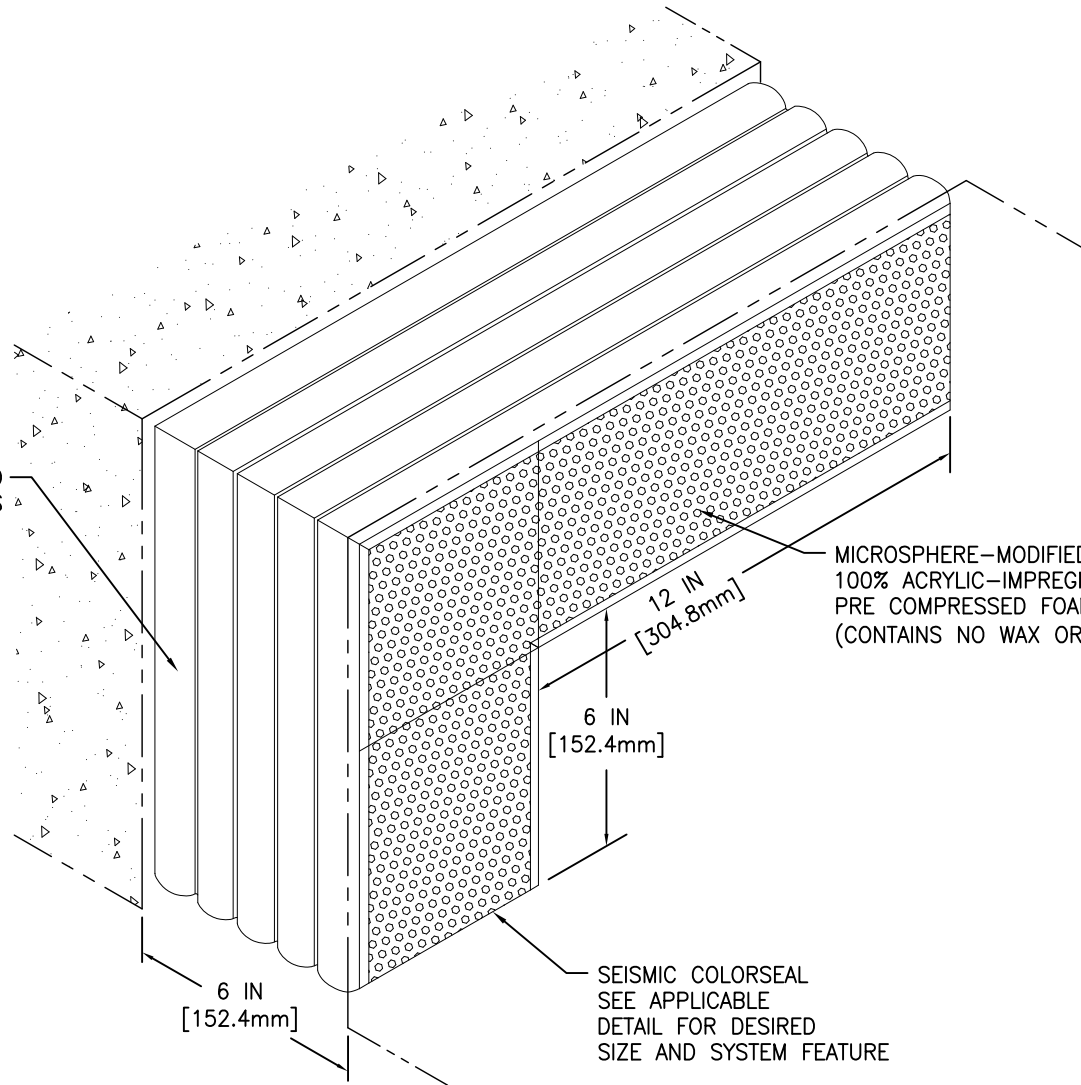

MICROSPHERE-MODIFIED,  
100% ACRYLIC-IMPREGNATED  
PRE COMPRESSED FOAM.  
(CONTAINS NO WAX OR WAX COMPOUNDS)

SEISMIC COLORSEAL  
SEE APPLICABLE  
DETAIL FOR DESIRED  
SIZE AND SYSTEM FEATURE

MOVEMENT:  $\pm 50\%$  (TOTAL 100%) OF NOMINAL MATERIAL SIZE

## EMSEAL JOINT SYSTEMS LTD.

COS-0600 UNIVERSAL 90 DOWNTURN

THIS DOCUMENT CONTAINS INFORMATION OF A CONFIDENTIAL NATURE AND IS PROPRIETARY TO EMSEAL JOINT SYSTEMS LTD. ANY UNAUTHORIZED USE WILL BE PROSECUTED. THIS DRAWING IS PROTECTED BY COPYRIGHT, THE RIGHT TO REPRODUCE IN ANY FORM BEING THE EXCLUSIVE RIGHT OF EMSEAL JOINT SYSTEMS LTD. ANY UNAUTHORIZED REPRODUCTION WHETHER IN TWO OR THREE DIMENSIONS WILL BE PROSECUTED. © 2014 EMSEAL JOINT SYSTEMS LTD.

DRAWN BY: JNM	DATE: 2015/07/30	SCALE: N.T.S.	SHEET No: 1 OF 1
------------------	---------------------	------------------	---------------------

PART NUMBER:  
COS\_0600\_U-90\_DOWNTURN