

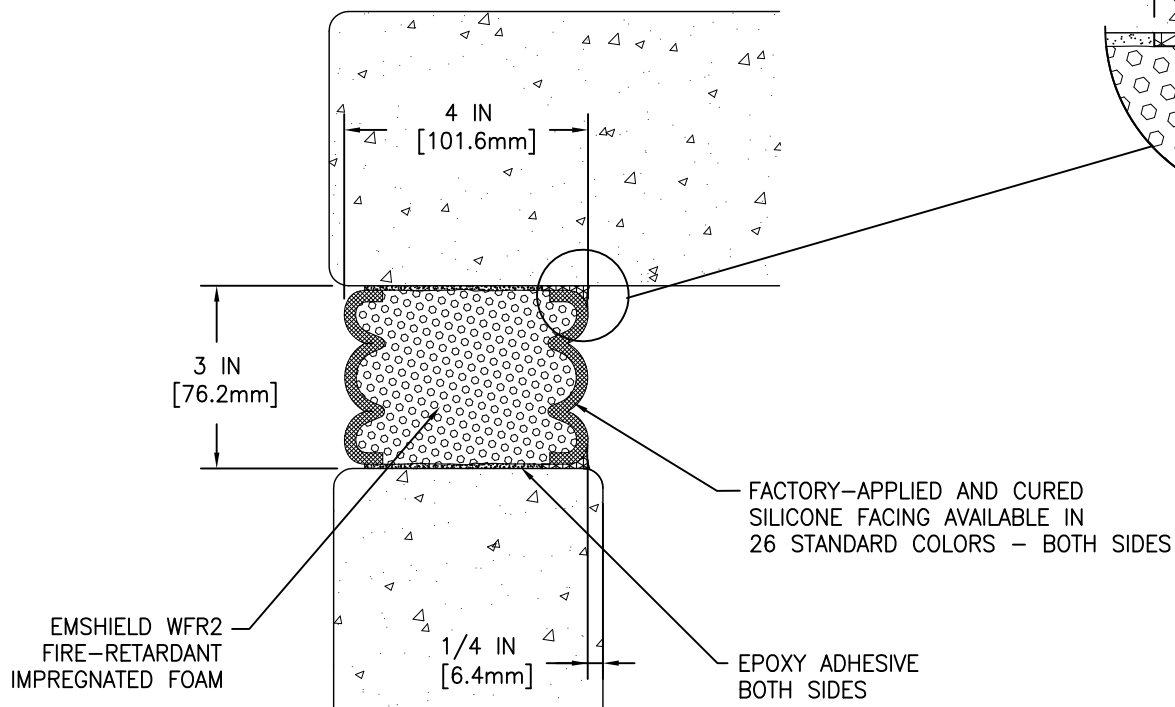

System # WW-D-1079
System # JF131

FIELD-APPLIED MIN. 3/4-INCH (19.1mm)
DEEP INJECTED SEALANT BAND AND CORNER BEAD
ALONG SIDE OF WFR2 AS SHOWN - BOTH SIDES
(SILICONE SUPPLIED BY EMSEAL)

APP. 3/4 IN
[19.1mm]



MOVEMENT: ±50% (TOTAL 100%) OF NOMINAL MATERIAL SIZE

EMSEAL'S EMSHIELD WFR2 HAS BEEN TESTED IN ACCORDANCE WITH UL 2079 IN THE CONFIGURATION DEPICTED IN SYSTEM # WW-D-1079. USE OF THIS MATERIAL IN WALL ASSEMBLY CONFIGURATIONS OTHER THAT DEPICTED IN UL SYSTEM # WW-D-1079 WILL NOT ENCUMBER OR LOWER THE RESISTANCE OF THE WALL BUT IS DONE SO AT THE DESIGNERS' DISCRETION AND RESPONSIBILITY FOR DESIGN OF A FIRE RATED WALL ASSEMBLY THAT MEETS APPLICABLE STANDARDS FOR THE PROJECT AND WHICH ADDITIONALLY IS CAPABLE OF RESISTING THE APPROXIMATELY 2.5 PSI (120 LBS PER FOOT OF JOINT BASED ON 4-INCH DEPTH OF SEAL) BACKPRESSURE OF THE WFR2 MATERIAL.

EMSEAL JOINT SYSTEMS LTD.

EMSHIELD WFR2-0300 WALL TO WALL INSIDE CORNER

THIS DOCUMENT CONTAINS INFORMATION OF A CONFIDENTIAL NATURE AND IS PROPRIETARY TO EMSEAL JOINT SYSTEMS LTD. ANY UNAUTHORIZED USE WILL BE PROSECUTED. THIS DRAWING IS PROTECTED BY COPYRIGHT, THE RIGHT TO REPRODUCE IN ANY FORM BEING THE EXCLUSIVE RIGHT OF EMSEAL JOINT SYSTEMS LTD. ANY UNAUTHORIZED REPRODUCTION WHETHER IN TWO OR THREE DIMENSIONS WILL BE PROSECUTED. © 2014 EMSEAL JOINT SYSTEMS LTD.

DRAWN BY: JNM	DATE: 2015/06/18	SCALE: N.T.S.	SHEET No: 1 OF 1
------------------	---------------------	------------------	---------------------

PART NUMBER:
WFR2_0300_WW_INSIDE_CORNER