

FACTORY-APPLIED AND CURED
TRAFFIC-GRADE SILICONE FACING
(PECORA 301)

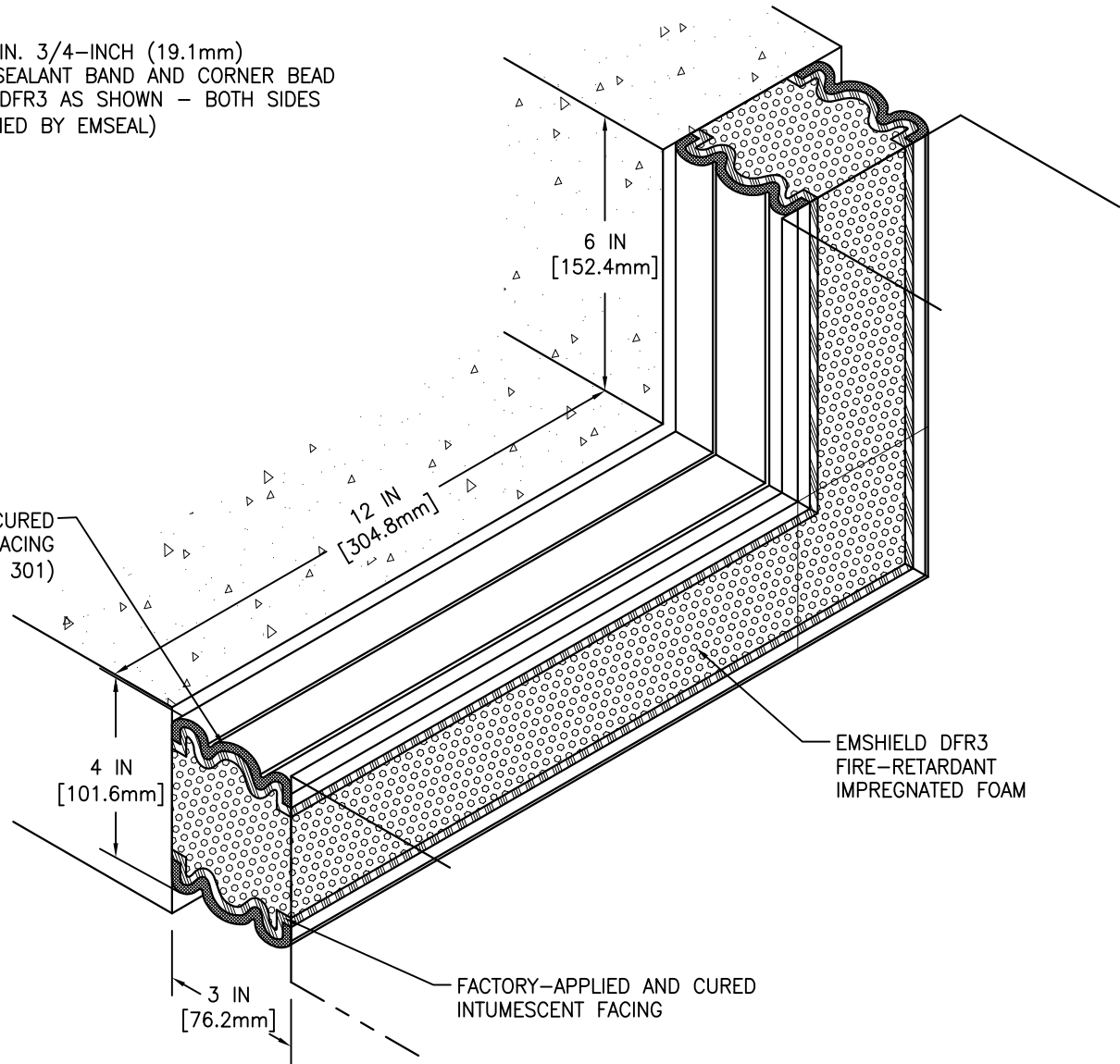

MOVEMENT: ±25% (TOTAL 50%) OF NOMINAL MATERIAL SIZE

EMSEAL'S EMSHIELD DFR3 HAS BEEN TESTED IN ACCORDANCE WITH UL 2079 IN THE CONFIGURATION DEPICTED IN SYSTEM # FF-D-1090. USE OF THIS MATERIAL IN WALL ASSEMBLY CONFIGURATIONS OTHER THAN THAT DEPICTED IN UL SYSTEM # FF-D-1090 WILL NOT ENCUMBER OR LOWER THE RESISTANCE OF THE WALL BUT IS DONE SO AT THE DESIGNERS' DISCRETION AND RESPONSIBILITY FOR DESIGN OF A FIRE RATED WALL ASSEMBLY THAT MEETS APPLICABLE STANDARDS FOR THE PROJECT AND WHICH ADDITIONALLY IS CAPABLE OF RESISTING THE APPROXIMATELY 2.5 PSI (120 LBS PER FOOT OF JOINT BASED ON 4-INCH DEPTH OF SEAL) BACKPRESSURE OF THE DFR3 MATERIAL.

EMSEAL JOINT SYSTEMS LTD.

EMSHIELD DFR3-0300 INSIDE VERTICAL PLANE UNIVERSAL-90

THIS DOCUMENT CONTAINS INFORMATION OF A CONFIDENTIAL NATURE AND IS PROPRIETARY TO EMSEAL JOINT SYSTEMS LTD. ANY UNAUTHORIZED USE WILL BE PROSECUTED. THIS DRAWING IS PROTECTED BY COPYRIGHT, THE RIGHT TO REPRODUCE IN ANY FORM BEING THE EXCLUSIVE RIGHT OF EMSEAL JOINT SYSTEMS LTD. ANY UNAUTHORIZED REPRODUCTION WHETHER IN TWO OR THREE DIMENSIONS WILL BE PROSECUTED. © 2014 EMSEAL JOINT SYSTEMS LTD.

DRAWN BY: SWR	DATE: 2016/02/01	SCALE: N.T.S.	SHEET No: 1 OF 1
------------------	---------------------	------------------	---------------------

PART NUMBER:

DFR3_0300_U-90_UPTURN