



## DSM SYSTEM

DO NOT OPEN ANY PACKAGES or install this material until all members of your crew have read and understand these instructions as well as all relevant MSDS sheets. If you do not understand any part of these instructions CALL EMSEAL: 800-526-8365 or 508-836-0280

This document does not purport to address all of the safety concerns, if any, associated with this product's use. It is the responsibility of the user of this document to establish appropriate safety and health practices and to determine the applicability of regulatory limitations prior to use. The use of a dust mask, safety goggles and gloves is recommended. Keep out of reach of children.

**IMPORTANT: This product cannot perform its intended function if not properly installed.**

# INSTALL DATA

## 1 Equipment & Material Storage

In addition to safety equipment required to comply with applicable Federal, state and local safety regulations, equipment to prepare and repair the joint-faces, as well as normal tools of the trade, the following are required:

### Equipment Checklist:

- Tape measure
- Mixing paddle and heavy-duty, low-speed drill for mixing epoxy adhesive
- Caulking gun for 10-oz silicone tubes provided
- Long-bladed, serrated bread knife
- Hacksaw
- Miter box or miter block
- Spray bottle with water
- Duct Tape (2 ½ times the length of joint)
- Spatula to scrape epoxy from can
- Chemical-resistant gloves
- 2-inch wide (50mm) margin trowels for applying epoxy adhesive on joint faces
- Caulk knives for tooling sealant bands
- Toluene\* for cleaning joint-faces, trowels and mixer tools
- Clean lint-free, 100% cotton rags

**Cold Days:** Store Sealant, off the floor, inside at above 68° F (20° F). It will recover slower when cold and faster when warm.

**Very Hot Days:** Keep sealant out of direct sun when the temperature is greater than 60° F (15° C) until immediately prior to installation into joint.

## 2 Prepare & Solvent-Wipe Joint Faces

### Concrete:

- Remove loose particles and weak concrete to ensure sound concrete substrate. Spalls, chipped edges and uneven surfaces must be repaired using suitable patching material and proper patching geometry and techniques. Joint faces must be parallel.
  - Joints must have unobstructed depth greater than or equal to the full depth of the largest material supplied plus 1/2-inch (6mm).
  - Remove all contaminants by sandblasting or grinding to ensure a thoroughly clean and sound substrate for the full sealant depth.
- NOTE: DO NOT use a wire wheel--this will polish the substrate and cause bond-failure.**
- Dry all wet surfaces.
  - **NOTE: Do not use flame to dry substrate--this will leave carbon on the substrate and cause bond-failure.**
  - Wipe joint faces with solvent-dampened, lint-free rags to remove all concrete dust and contaminants.

### Metal:

- Sandblast or grind to rough, white metal and solvent-wipe immediately prior to applying DSM epoxy.

**IMPORTANT: Ensure that no oxidation (rusting) occurs before the epoxy is applied.**

**Other Substrates:** Contact EMSEAL.

## 3 Measure Joint Width & Find Correct Size Material

- Measure joint width at deck surface and below to ensure joint faces are parallel.
- Material has been supplied to suit your mean temperature field-measured joint widths. Widths of material supplied are marked on each stick of material. Find correct box and open it.
- Compare width of material supplied as marked on each stick against mean joint width. Actual width of material as measured between hardboard will be slightly less than marked size because material is over-compressed for ease of installation.

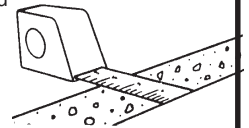

**NOTE: If unsure of correct material selection, consult EMSEAL.**

**IMPORTANT: Do not remove outer plastic packaging until you have read and understand the rest of these instructions as material may expand prematurely.**

## 4 Start with Universal-90 Installation

Changes in plane, either up or down, require the use of factory-fabricated Universal-90's from EMSEAL.

**Sequencing:** Install factory-fabricated transition and/or termination pieces first. Connect straight run material to in-place terminations and transitions.

**Note: If installing very long runs of material, to avoid having to work at distant ends of a joint run and in order to prevent epoxy from fully curing, the final factory-fabricated Universal-90 termination can be installed as the second-to-last piece.**

Cut closing pieces 3/8-inch (10mm) longer than the opening to be joined. Compress material longitudinally to fit.

## 5 Mask Deck & Mix Epoxy Adhesive

- Using duct tape, tape off the deck on both sides of the joint.

### Mix Epoxy

- EMSEAL epoxy adhesive may be used in the 40° F (5° C) to 95° F (35° C) temperature range.
- Using a trowel, transfer the entire contents of Part B (hardener) into the contents of Part A (base).
- Mix the material thoroughly (3 minutes) with a drill and mixing paddle. Scrape the walls and bottom of the container to ensure uniform and complete mixing.
- Always mix component B (hardener) into component A (base). Ensure that a uniform gray color with no black or white streaks is obtained.

**IMPORTANT: DO NOT thin the epoxy.**

- **Precaution:** Wear chemical-resistant gloves and/or barrier hand cream when handling liquid sealant or epoxy. Remove promptly from skin with a commercial hand cleaner before eating or smoking. Avoid inhaling vapors.

## 6 Apply Epoxy to Substrate, Unwrap DSM

Ensure that the mixed epoxy adhesive is applied to the substrate before the pot life has expired (10 - 30 minutes depending on the ambient temperature).

**WARNING:** Epoxy will harden more quickly when left in the pot. Apply it onto the joint face as soon as possible.

**IMPORTANT:** The epoxy must still be uncured when installing DSM foam into the joint-gap.

If the epoxy cures before installing the DSM foam then reapply new epoxy. If work is interrupted for more than 2 hours after initial cure then grind the old epoxy and apply new wet epoxy.

**IMPORTANT:** While one or more workers are applying epoxy to the joint faces, others must prepare the DSM foam. The DSM foam is kept under compression by plastic wrapping and hardboard on both sides.

- Slit the plastic packing by cutting on the hardboard and remove hardboard and inner release liner. DO NOT cut along the silicone bellows face.

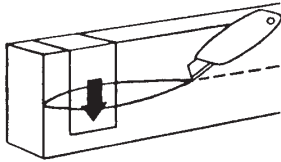

**IMPORTANT:** Work quickly and deliberately after cutting the shrink-wrap to avoid material expanding beyond a usable size.

## 7 Wipe Release Agent off Silicone Facing

- For packaging and production reasons, the silicone facing is coated in the factory with a release agent.
- Prior to installation, this agent must be wiped off in order for the injected sealant bands described in Step 10 to adhere to the silicone facing and to avoid contamination of the substrate at this point.
- Lightly, quickly and thoroughly wipe the cured silicone facing with a lint-free rag made damp with water to remove the release agent.

**TIP:** Use the hardboard packaging as a flat, clean working surface.

- **Clean Up:** Remove epoxy and silicone sealant from equipment before it cures using MEK\*, Toluene\*, or Xylene\*. These solvents are not effective after the epoxy or silicone has cured. Cured material may be removed by cutting it away with sharp tools or sandpapering. (\*Solvents mentioned or referred to are toxic and flammable. Observe solvent manufacturer's precautions and refer to Material Safety Data Sheets as well as local and federal requirements for safe handling and use.)

## 8 Install First DSM Foam Length into Joint & Apply Silicone to Bellows Face

- Immediately after coating foam sides with epoxy, install the foam into the joint. Ensure that epoxy on the joint face has not cured.
- When installed, the DSM must be recessed so that the top of the bellows is flush or slightly below the deck surface.
- Note: When material is correctly expanded for a snug fit it will support its own weight in the joint.
- Feed material into joint, starting from one end. The material should fit snugly and must be eased into the joint with steady, firm pressure.
- Leave the end to be joined to the next length sticking slightly proud of the joint.
- Repeat step #7 for each new stick.
- On the end of the next stick, using a bulk gun and the sausages of silicone provided, apply the liquid silicone to the exposed face of the silicone bellows. Avoid spreading silicone sealant to foam.

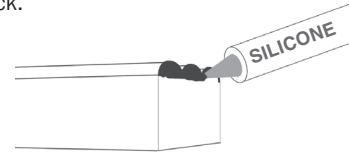

## 9 Install Next Length. Repeat.

- Work in one direction towards the previously installed length or end of joint. Do not stretch material.
- Leave the end to be joined to the previous length sticking proud of the joint—push the joining faces together.
- **Push Hard** on the stick to compress joints firmly together. Ensure there are no voids at joints.
- Once the full length is installed, push the protruding joint into the joint and tool off the excess silicone.
- During low temperature installation, provide as much ambient heat as possible around installed BEJS foam to accelerate recovery.

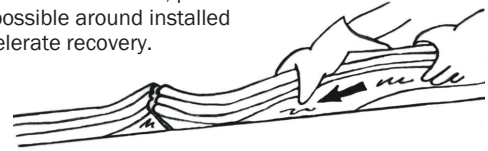

## 10 Inject Silicone Sealant Bands at Substrates & Tool Excess Silicone

- Wipe any excess epoxy from top of material using a clean rag.
- Before the epoxy cures, force the tip of the silicone nozzle between the substrate and the DSM foam. Inject a 3/4-inch (20mm) deep silicone sealant band between the foam, cured silicone facing and the joint-face.
- Tool the freshly applied silicone firmly to blend with the substrates and cured bellows facing, and to ensure a proper bond and seamless appearance.
- Where DSM foam meets at butt joints, tool the excess silicone that squeezes out from the top and between the bellows.

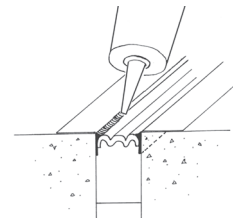

**IMPORTANT:** Silicone left between the wrinkles of the bellows could constrain movement -- using a caulk knife, remove excess sealant and blend what remains into the bellows.

## 11 Transitions, Ends, and Special Conditions

**Sequencing:** Install factory-fabricated transition and/or termination pieces first. Connect straight run material to in-place terminations and transitions. Apply the joining silicone (at the bellows ends only) on the straight length before inserting it into the joint (see step #8). Bring the joint firmly against the butt end of the already installed Universal-90 and push the straight run stick towards this joint throughout the process of installing it.

**Note:** If installing very long runs of material, to avoid having to work at distant ends of a joint run and in order to prevent epoxy from fully curing, the final factory-fabricated Universal-90 termination can be installed as the second-to-last piece.

Cut closing pieces 3/8-inch (10mm) longer than the opening to be joined. Compress material longitudinally to fit.

### UNIVERSAL-90 TRANSITIONS

Universal-90's are designed to continue the DSM through changes in plane such as at floor-to-walls, curbs, treads and risers, or other such changes in slab thickness. Unlike straight-run lengths, BOTH sides of Universal-90's are silicone coated with bellows so there is no top or bottom. They can be turned over to be used either as an upturn or a downturn. Install factory-fabricated transition and/or termination pieces first. Universal-90's may also be used to transition to another EMSEAL foam product.

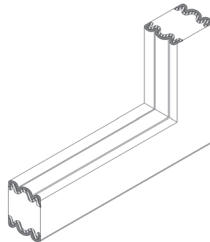

Connect straight run material to in-place terminations and transitions (see step #8). Cut closing pieces 3/8-inch (10mm) longer than the opening to be joined. Compress material longitudinally to fit.

### UNIVERSAL-90 TERMINATIONS

When DSM does not run in a closed loop it needs to be terminated with a factory-fabricated Universal-90. Prepare gap and foam sides with epoxy adhesive in the same manner as DSM sticks. As with Universal-90 transitions, install factory-fabricated transition and/or termination pieces first.

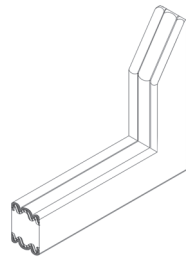

Connect straight run material to in-place terminations and transitions (see step #8). Cut closing pieces 3/8-inch (10mm) longer than the opening to be joined. Compress material longitudinally to fit. The factory-sealed end acts as the termination and points up or down to best block or direct water flow.

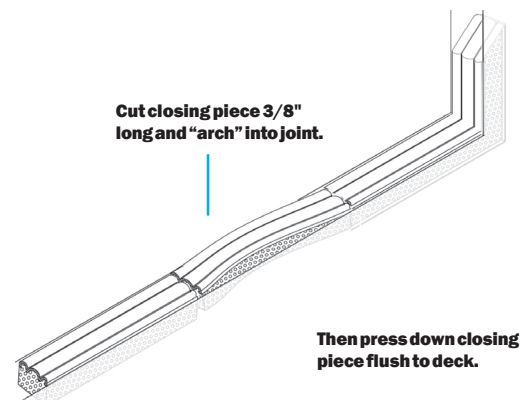
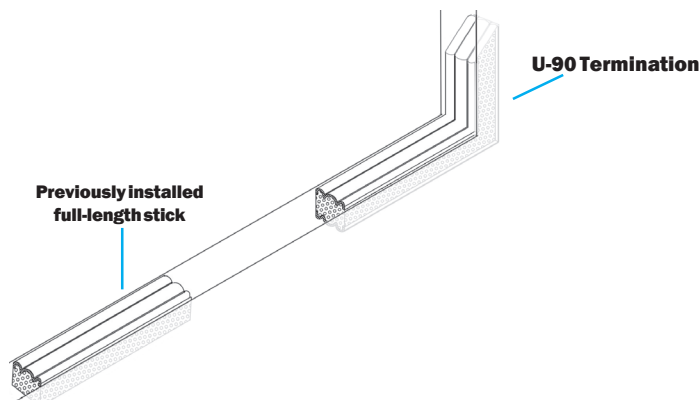

## 11 Transitions, Ends, and Special Conditions

(Continued)

### FLAT CORNERS:

- Work towards the corner so that the last two pieces to install will join at the corner.
  - Cut each piece to be joined 3/8-inch (10 mm) longer than needed.
  - Install one piece so that it runs through the intersecting joint-gap. Firmly push and compress the extra length so that a tight fit in the corner is achieved.
  - Firmly butt intersecting pieces into sides of already placed material.
- \*\*IMPORTANT: Be sure that there is no epoxy on the sides or faces of foam at a butt join.**
- Using a caulk knife, remove any excess sealant and blend the liquid silicone into the bellows to preserve the bellow shape.
  - Inject a bead of liquid silicone where the silicone faces join and where the silicone faces meet the substrate.

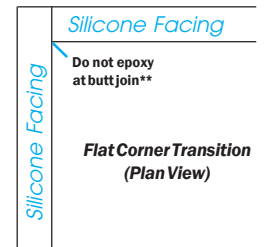

### CROSSES AND TEES:

- Run one piece of material across the intersection. Coat silicone bellows end (only) of the intersecting material with silicone. Firmly butt intersecting pieces into sides of already placed material.
- Using a caulk knife, remove any excess sealant and blend the liquid silicone into the bellows to preserve the bellows shape.

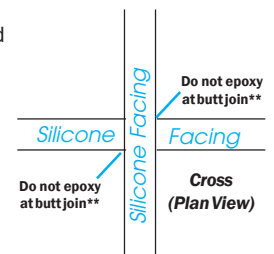

### SILICONE-COAT ANY EXPOSED FOAM ENDS

**IMPORTANT: If the DSM runs are not part of a closed loop system, and Universal-90 terminations are not used (run does not terminate in an upturn or downturn), lightly coat any exposed foam ends using the liquid silicone sealant provided. This is critical in ensuring that the watertightness of the foam is sealed.**

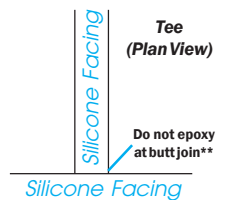

**NOTES:**